

# ACCESSORIES

# SHELVING

## 19" FIXED LITE SHELVES SERIES DP-PT

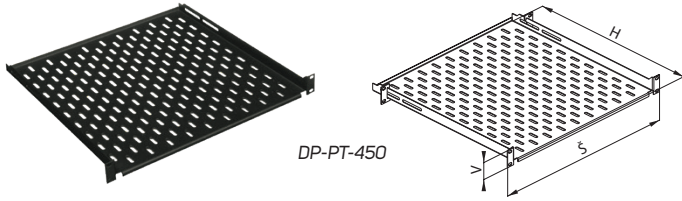

- 1.5 mm sheet steel
- Supporting brackets included
- Color: powder-coated RAL 9005
- Load rating max. 20 kg balanced load; maximum load rating decreased to 25 % when mounted on front pair of vertical extrusions only (shelf depth 150, 250, and 350 mm)
- Longer supporting bracket DP-PO-PD available for use
- Package includes: 1× shelf, 2× rear brackets

Code	H (in U)	W	D (mm)	Min-max dist. <sup>1</sup>	Max dist. <sup>2</sup>	Package
DP-PT-150	1	19"	150	75–121	370	1 pc
DP-PT-250	1	19"	250	125–221	470	1 pc
DP-PT-350	1	19"	350	175–321	570	1 pc
DP-PT-450	1	19"	450	225–421	670	1 pc
DP-PT-550	1	19"	550	275–521	770	1 pc
DP-PT-650	1	19"	650	325–621	870	1 pc
DP-PT-750	1	19"	750	375–721	970	1 pc
DP-PT-850	1	19"	850	425–821	1070	1 pc

<sup>1</sup> Between standard front and rear brackets (in mm).

<sup>2</sup> Between front and rear brackets—with DP-PO-PD (in mm).

## 19" FIXED SHELVES SERIES DP-PO

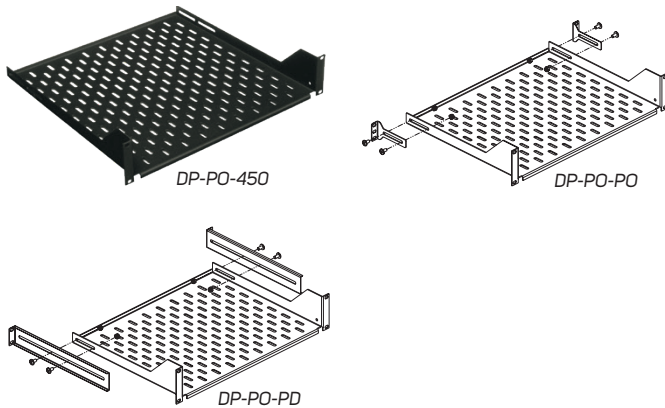

- 2 mm sheet steel
- Support brackets optional
- Color: powder-coated RAL 9005
- Load rating max. 60 kg balanced load (when supporting brackets used—ordered separately); load rating decreased to 25 % when mounted on front pair of vertical extrusions only—shelf depth 150, 250 and 350 mm
- Package includes: DP-PO-xxx: 1× shelf

Code	H (in U)	W	D (mm)	Min-max dist. <sup>1</sup>	Max dist. <sup>2</sup>	Package
DP-PO-150	1	19"	150	75–180	385	1 pc
DP-PO-250	1	19"	250	125–265	470	1 pc
DP-PO-350	2	19"	350	230–380	585	1 pc
DP-PO-450	2	19"	450	260–480	685	1 pc
DP-PO-550	2	19"	550	360–580	785	1 pc
DP-PO-650	2	19"	650	460–680	885	1 pc
DP-PO-750	2	19"	750	560–780	985	1 pc
DP-PO-850	2	19"	850	660–880	1085	1 pc

<sup>1</sup> Between standard front and rear brackets (in mm).

<sup>2</sup> Between front and rear brackets—with DP-PO-PD (in mm).

### SUPPORTING BRACKETS

Code	Type	Package	Length (mm)	H (in U)
DP-PO-PO	Standard	1 pair	88	1
DP-PO-PD *	Extended	1 pair	298	1

\* Compatible with DP-PO-xxx, DP-PT-xxx.

## 19" FIXED HIGH-LOAD SHELVES SERIES DP-PZ

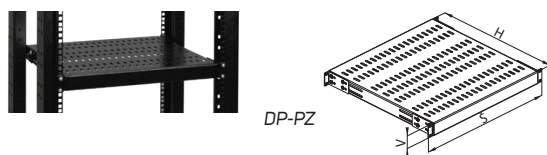

- 2 mm sheet steel, reinforced with metal bars
- Four supporting brackets (for mounting on vertical extrusions) included
- Color: powder-coated RAL 9005
- Load rating max. 100 kg balanced load
- Package includes: 1× shelf, 4× brackets, 16× screws M6, 16× nuts M6

Code	H (in U)	W	D (mm)	Min-max distance *	Package
DP-PZ-450	1	19"	450	113–463	1 pc
DP-PZ-550	1	19"	550	213–563	1 pc
DP-PZ-650	1	19"	650	313–663	1 pc
DP-PZ-750	1	19"	750	413–763	1 pc
DP-PZ-850	1	19"	850	513–863	1 pc

\* Between standard front and rear brackets (in mm).

## 19" PULL-OUT SHELVES SERIES DP-PO-V

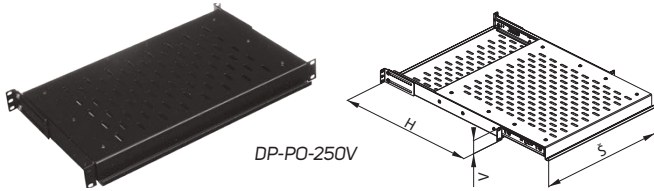

DP-PO-250V

- 1.5 mm sheet steel
- Height: 1U
- Equipped with one pair of side telescopic rails
- Supporting brackets included
- Color: powder-coated RAL 9005
- Load rating max. 25 kg balanced load; maximum load rating decreased to 25 % when mounted on front pair of vertical extrusions only (shelf depth: 250 and 350 mm)
- Package includes: 1x shelf, 2x rear brackets, 4x screws M5

Code	H (in U)	W	D (mm)	Min-max dist.*	Drawout part max.	Package
DP-PO-250V	1	19"	271	155–370	160 mm	1 pc
DP-PO-350V	1	19"	371	255–470	260 mm	1 pc
DP-PO-450V	1	19"	471	355–570	325 mm	1 pc
DP-PO-550V	1	19"	571	455–670	410 mm	1 pc
DP-PO-650V	1	19"	671	555–770	485 mm	1 pc
DP-PO-750V	1	19"	771	655–870	520 mm	1 pc

\* Between standard front and rear brackets (in mm).

## 19" PULL-OUT HIGH LOAD SHELVES SERIES DP-PZ-V

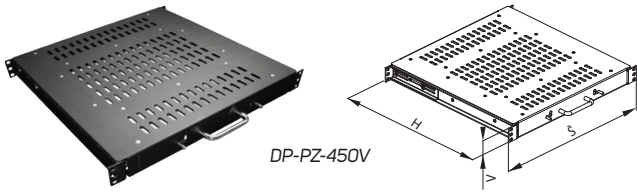

DP-PZ-450V

- 2 mm and 2.5 mm sheet steel
- Height: 1U
- Max. pull-out 450 mm
- Color: powder-coated RAL 9005
- Load rating max. 80 kg balanced load
- Package includes: 1x shelf

Code	H (in U)	W	D (mm)	Min-max distance *	Package
DP-PZ-450V	1	19"	471	296–507	1 pc
DP-PZ-550V	1	19"	571	406–607	1 pc

\* Between standard front and rear brackets (in mm).

## SUPPORTING RAILS

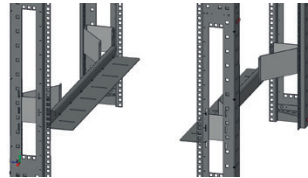

DP-DU-75S-800

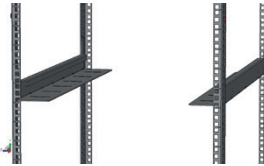
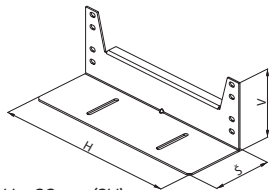

DP-DU-75S-600

H—88 mm (2U)  
W—80 mm

- 2 mm sheet steel
- Mountable on vertical extrusion side holes (with DP-MO-01 mounting kit, not included)
- Color: powder-coated RAL 9005
- Space between rails provides effective cooling of active devices
- Load rating max. 50 kg balanced load
- Package includes:
  - DP-DU-xxxx: 2x supporting rails
  - DP-DU-S75: 2x supporting rails, 4x brackets for 800 mm racks, 36x screws M5, 16x floating nuts M5
- Compatible with L-Type extrusions; other information upon request

Rack *	Max. DP-DU
RDF 80/80	700
RDF 80/100	900
RSF 60/80	700
RSF 60/100	900
RSF 80/80	700
RSF 80/100	900
Rx7 60/60	500
Rx7 60/80	700
Rx7 60/100	900
Rx7 80/80	700
Rx7 80/100	900

\* Replace "x" with "I" or "M".

SUPPORTING RAILS			
Code	Distance between front and rear vertical L-type extrusions (mm)	Depth (mm)	Package
DP-DU-300	296	242	1 pair
DP-DU-400	396	342	1 pair
DP-DU-500	496	442	1 pair
DP-DU-600	596	542	1 pair
DP-DU-700	696	642	1 pair
DP-DU-800	796	742	1 pair
DP-DU-900	896	842	1 pair
DP-DU-1000	996	942	1 pair
DP-DU-S75 *	740	692	1 pair

\* Load rating of 100 kg for 600 and 800 mm width.

## 19" PULL-OUT DRAWER DP-DD

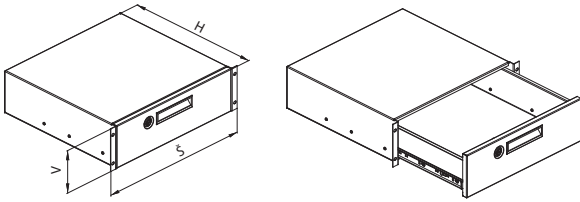

- 1.25 and 1.5 mm sheet steel
- Height: 3U
- Max. pull-out distance 280 mm
- Color: powder-coated RAL 9005
- Load rating max. 10 kg balanced load
- Package includes: 1x drawer

Code	H (in U)	W	D (mm)	Package
DP-DD-03	3	19"	430	1 pc

## 19" PULL-OUT KEYBOARD HOLDER SERIES DP-PV

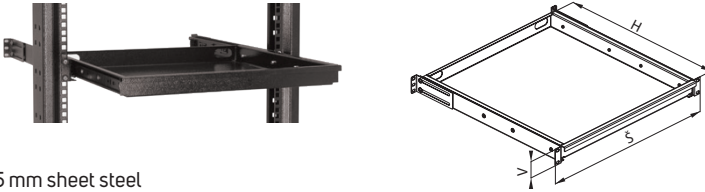

- 1.5 mm sheet steel
- Max. keyboard width 400 mm and height 36 mm
- Shelf depth: 480 mm
- Max. pull-out distance 330 mm
- Color: powder-coated RAL 9005
- Supporting brackets included
- Supporting brackets DP-PV-PD for installation into 800 and 1000 mm deep racks (optional)
- Package includes: 1x keyboard holder, 2x rear brackets, 4x screws M5, 1x self-adhesive velcro tape

Code	H (in U)	W	D (mm)	Package
DP-PV-02	1	19"	480	1 pc

## 19" FOLDING KEYBOARD HOLDER SERIES DP-PV

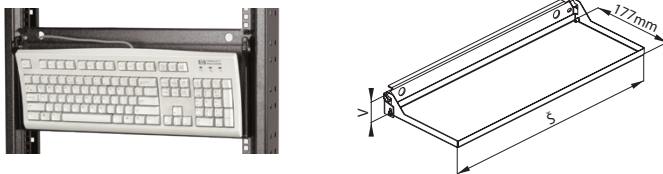

- Enables keyboard placement in front of sliding vertical extrusions
- Max. keyboard size 480x175 mm
- Color: powder-coated RAL 9005
- Height: 1U
- Fix keyboard to shelf using self-adhesive velcro—  
8 pcs of size 12x25 mm (included)
- Package includes: 1x keyboard holder, 1x self-adhesive velcro tape

Code	H (in U)	W	Package
DP-PV-01	1	19"	1 pc

## 21" ADAPTORS

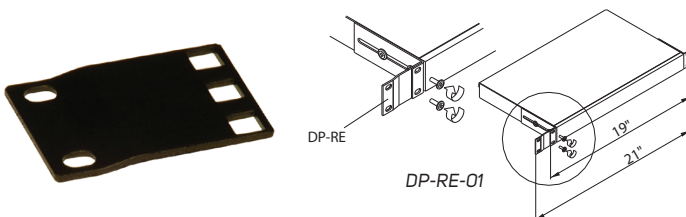

- Allows for use of 19" equipment in 21" rack
- Color: powder-coated RAL 9005
- Package includes: 1x adaptor

Code	H (in U)	Package
DP-RE-01	1	1 pc
DP-RE-02	2	1 pc
DP-RE-03	3	1 pc

# FIBER-OPTIC PRODUCTS

## 19" FIXED FIBER-OPTIC SPLICE BOX

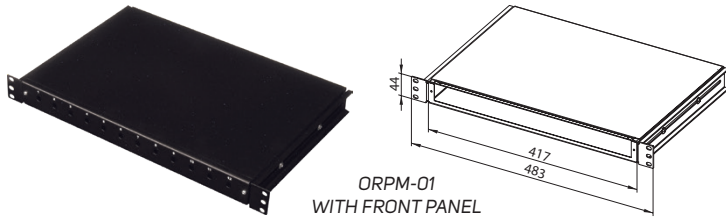

ORPM-01  
WITH FRONT PANEL

- Type: fixed
- Height: 1U
- Modular front panels not included (see below)
- Up to 24 positions for FO couplings

- Front panel must be selected and ordered separately
- Cable entry openings in rear
- Holes not in use can be covered with blank modules

- Installed in racks with adjustable holders
- Installation kit for splice cassettes and inner organizer (included)
- Wide range of accessories (optional)

- Color: powder-coated RAL 9005
- Package includes:
  - ORPM-01: 1x fibre-optic box,
  - 2x cable holders, 2x 19" brackets,
  - 4x screws M5, 2x screws M4
  - OR-xxxx: 1x front panel

Code	H (in U)	W	D (mm)	Description	Package
ORPM-01	1	19"	300	Fixed	1 pc



### ACCESSORIES FOR FIBER-OPTIC SPLICE BOXES

Code	Description	Package
ORO-K200	Splice cassette	1 pc
ORO-PG11	PG11 coupling	10 pcs
ORO-PG16	PG16 coupling	10 pcs
ORO-ZPG11	Cover of opening for PG11 coupling	10 pcs
ORO-ZPG16	Cover of opening for PG16 coupling	10 pcs
ORO-01	Front organizer for ORPM	1 pc
ORO-02	Front organizer for ORVM	1 pc
ORO-03	Rear organizer	1 pc

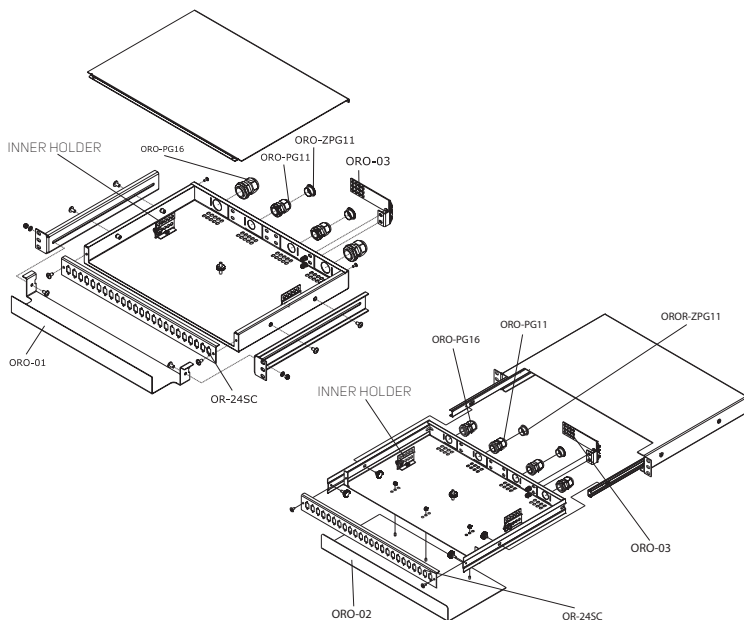

### TYPES OF MODULAR FRONT PANELS

Code	Number of holes for FO couplings				Package
	8	12	16	24	
OR-xxST	•	•	•	•	1pc
OR-xxSC	•	•	•	•	1pc
OR-xxDSC	•	•	•	•*	1pc
OR-xxFC	•	•	•	•	1pc
OR-xxFCD	•	•	•	•	1pc

\* Without numbering and holes for screws.

## 19" TELESCOPIC FIBER-OPTIC SPLICE BOXES



ORVE-01-250

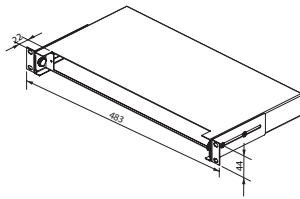

- Used to terminate optical cables in racks
- Type: telescopic
- Height: 1U
- Modular front panels not included – see table on page 115
- Up to 24 positions for FO couplings

- Front panel must be selected and ordered separately
- Cable entry openings in rear
- Holes not in use can be covered with blank modules
- Installs into racks with two sliding holders

- Installation kit for splice cassettes and inner organizer included (ORVM-01 only)
- Wide range of accessories (optional)
- Color: powder-coated RAL 9005

Package includes:

- ORVM-01: 1x fibre-optic box, 2x cable holders, 2x screws M4
- ORVE-01-250: 1x fibre-optic box, 2x 19" brackets, 6x screws M4

Code	H (in U)	W	D (mm)	Description	Package
ORVM-01	1	19"	320	Telescopic	1 pc
ORVE-01-250	1	19"	250	Telescopic	1 pc

## WALL-MOUNTING FIBER-OPTIC SPLICE BOXES

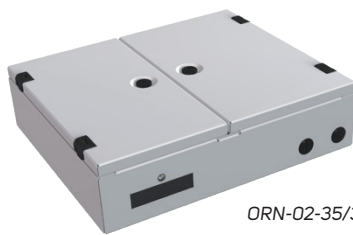

ORN-02-35/30

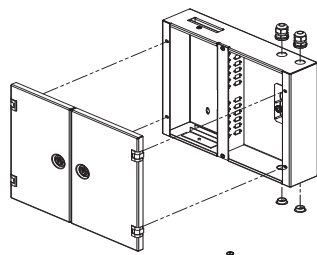

ORN-01

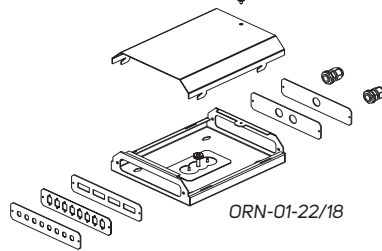

ORN-01-22/18

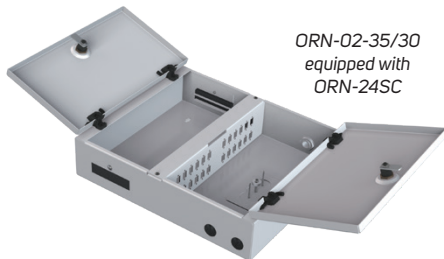

ORN-02-35/30 equipped with ORN-24SC



ORN-01-30/18

Code	Type	W × H (mm)	Package
ORN-01-30/18	Single	300 × 180	1 pc
ORN-01-22/18	Single	220 × 180	1 pc
ORN-02-35/30	Double	350 × 300	1 pc

- Wall-mounting fiber-optic splice boxes (used to terminate optical cables)
- Types:
  - double—size 350×300 mm; equipped with double-leaf door and lock
  - single—size 300×180 mm or 220×180 mm

- Modular panels with holes for couplings—see table below (must be ordered separately)
- In double FO splice-box up to 24 positions for ST or SC or FC or 12 DSC or FCD adapters
- In single FO splice-box up to 8 positions for ST or SC or FC or 4 DSC or FCD adapters

- Holes not in use can be covered with blank modules
- Cable entry through PG couplings (PG 9 for ORN-01 and PG 11 for ORN-02)
- Installation kit for splice cassette (ORO-K2000) included
- Color: powder-coated RAL 7035

Package includes:

- ORN-01-xx/xx: 1x WM box (box with cover), 1x screw M4, 4x screws M3, 1x nut M5
- ORN-02-xx/xx: 1x WM box (box with 2 doors), 2x PG11 with nuts, 2x Cover of opening for PG, 2x screws M4, 1x nut M5
- ORN-M-xxxx, ORN-xxxxx: 1x panel

PANELS FOR WALL-MOUNTING FIBER-OPTIC SPLICE BOXES		
ORN-01-30/18 and ORN-01-22/18	ORN-02-35/30	Package
ORN-M-8ST	ORN-24ST	1 pc
ORN-M-8SC	ORN-24SC	1 pc
ORN-M-4DSC	ORN-12DSC	1 pc
ORN-M-1PG	ORN-24FC	1 pc
ORN-M-2PG	ORN-12FCD	1 pc
ORN-M-8FC	–	1 pc
ORN-M-4FCD	–	1 pc

## Types of holes for fiber-optic connectors:

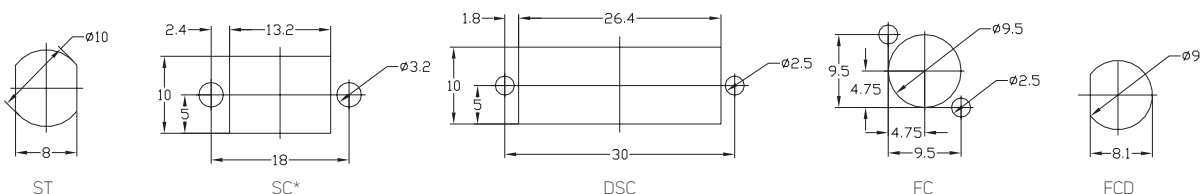

\* Used also for DUAL-LC (adapter needed).

Note: dimensions in mm (before powder coating).

# PATCH PANELS

## 19" PANELS FOR 110 CONNECTING BLOCKS

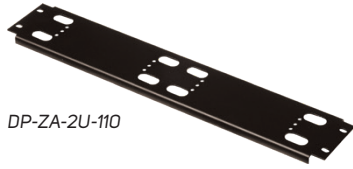

DP-ZA-2U-110

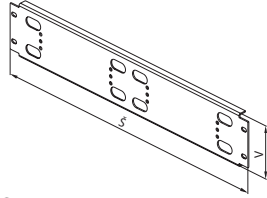

- For installation of 110 connecting blocks in 19" racks
- Available in 2U and 4U
- Color: powder-coated RAL 9005
- Can install up to 100 pairs for 2U height (incl. wire management)
- Package includes panels for 100 blocks

Code	H (in U)	For		Package
		110 block	Cable man. panel	
DP-ZA-2U-110	2	1 pc	1 pc	5 pcs
DP-ZA-4U-110	4	2 pcs	2 pcs	5 pcs

## 19" PATCH PANELS FOR KEYSTONE MODULES



PP-02-24

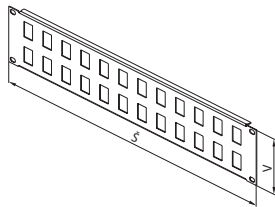

- For installation of Keystone rack modules
- Available in heights of 1U, 2U and 3U
- Can install up to 16 Keystone modules for 1U height (hole size 16.7×24.3 mm)
- Color: powder-coated RAL 9005
- Each module requires DP-KEY adaptor
- Package includes: 1x panel for Keystones

Code	H (in U)	Width	No. of positions	Package
PP-01-16	1	19"	16	1 pc
PP-02-24	2	19"	24	1 pc
PP-02-32	2	19"	32	1 pc
PP-03-48	3	19"	48	1 pc

## 19" PATCH PANELS FOR LSA-PLUS MODULES

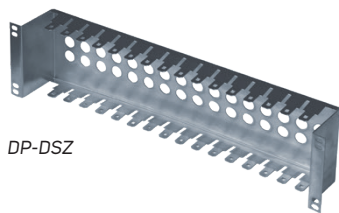

DP-DSZ

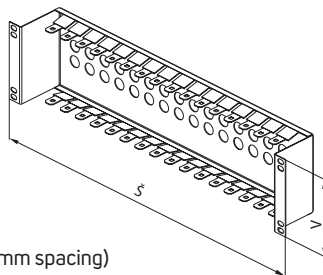

- For installation of LSA-PLUS modules (96 mm spacing)
- 16 positions for 10 pairs of LSA-PLUS modules
- Zinc-plated finish
- Package includes: 1x panel for LSA-PLUS modules

Code	H (in U)	Width	No. of positions	Package
DP-DSZ	2.5	19"	16	1 pc



# EARTHING BARS

## CABLE CLAMP BRACKET/EARTHING BAR FOR PATCH PANEL

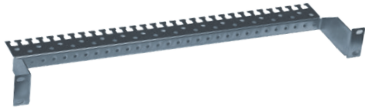

DP-HR-01

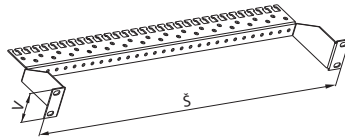

- For earthing installed equipment
- Height: 1U and 2U
- Holds cables with cable ties or PVC
- Suitable for use as earthing bar
- Zinc-plated finish
- Package includes:
  - DP-HR-01, DP-HR-02: 1x earthing bar
  - DP-HR-03: 5x earthing bar, 5x mounting kit DP-MO-01

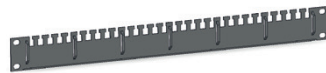

DP-HR-03

Code	Description	Package
DP-HR-01	19" cable clamp bracket/earthing bar for patch panel, 1U	1 pc
DP-HR-02	19" cable clamp bracket/earthing bar for patch panel, 2U	1 pc
DP-HR-03	19" cable clamp bracket/earthing bar cable/bundle of cables, 1U	1 set

## 19" PANEL WITH EARTHING BAR



DP-ZE-RAM

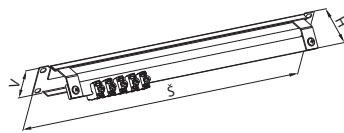

DP-ZE-CL

- Height: 1U
- Copper earthing rail with 5 earthing clips (DP-ZE-CL) included
- Color: powder-coated RAL 9005
- Package includes:
  - DP-ZE-RAM: 1x earthing rail, 5x clips DP-ZM-CL
  - DP-ZE-CL: 1x earthing clip

Code	Description	Package
DP-ZE-RAM	19" panel with earthing rail and 5 clips	1 pc
DP-ZE-CL	Earthing clip	1 pc

## EARTHING BAR

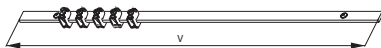

- For rack sizes 15–52U
- 25x5 mm copper bar
- Installation kit for rack mounting (included)
- Package includes: 1x earthing bar, 5x clips DP-ZM-CL, 4x screws M5, 4x nuts M5, 2x holder

Code	Height (in U)	Length (mm)	Package
DP-UL-15U	15	667	1 pc
DP-UL-21U	21,27	993	1 pc
DP-UL-42U	42, 45, 47, 48	1867	1 pc
DP-UL-52U	52	2325	1 pc

## EARTHING RAIL



- 22 terminals for cable diameters:
  - ø 1–10 mm<sup>2</sup>—solid conductor
  - ø 1–6 mm<sup>2</sup>—stranded conductor
- Nominal voltage—230/400 V
- Nominal current—40 A
- Mounting kit for installation (at either frame or extrusions)
- Ground cable 6 mm<sup>2</sup> with M8 lug, length 500 mm
- In accordance with standard specification LG-19
- Package includes: 1x earthing rail, 2x plastic holders, 2x screws M5

Code	Description	Package
DP-ZE-ER24	Earthing rail, 8x8 mm, 22 terminals, 40 A, ground cable	1 pc



# MODULAR PLINTHS



➤ **Plinths** are installed as both an aesthetic and stabilizing element instead of feet or castors. When a filter is used, the plinth supplies a sufficient amount of filtered air and can also be used for storing cables.

- Used with PREMIUM and iSEVEN rack series (RF1, RB1, Ri7 and RM7)
- Height: 100 mm
- Delivered unassembled; assembly hardware and instructions included
- Consists of:
  - set of corners and front/rear panels
  - set of side panels

*An example of an assembled modular plinth 800 × 1000 mm with a 100 mm height under RF1 rack. Individual parts of the plinth are shown below.*

COLOR:  RAL 9005  RAL 7035

## SET OF PLINTH CORNERS WITH FRONT/REAR PANELS + SET OF SIDE PANELS



DP-PR-L80 set

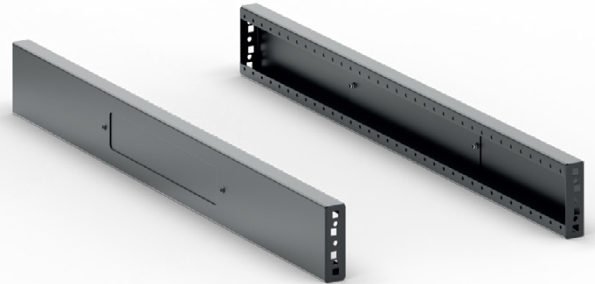

DP-P-S100 set



DP-PR-L80 + DP-P-S100



DP-PR-L30

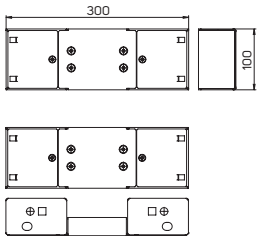

DP-PR-L40

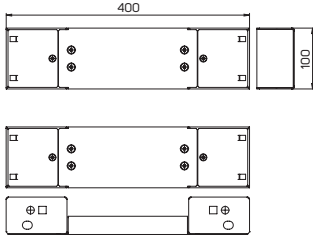

DP-PR-L60

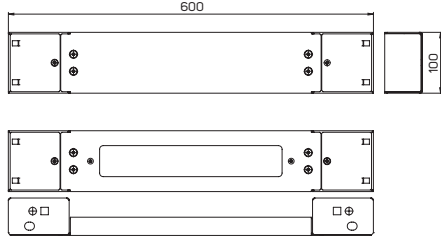

## SET OF CORNERS WITH FRONT/REAR PANELS

- Set of two plinth panels with corners for all racks
- Size corresponds to the width of the rack or CoolTeg Plus unit
- Load rating: 1700 kg
- Height: 100 mm

Code	Description	Width (mm)	Package *
DP-PR-L30	Plinths for 300 mm wide racks; includes front and rear panels with corners, mounting kit; height 100 mm	300	1 set
DP-PR-L40	Plinths for 400 mm wide racks; includes front and rear panels with corners, mounting kit; height 100 mm	400	1 set
DP-PR-L60	Plinths for 600 mm wide racks; includes front and rear panels with corners, mounting kit; height 100 mm	600	1 set
DP-PR-L80	Plinths for 800 mm wide racks; includes front and rear panels with corners, mounting kit; height 100 mm	800	1 set

\* Package includes:

- 2x corners with blank panel, mounting kit
- 2x corners with panel with cable entry, mounting kit

DP-PR-L80

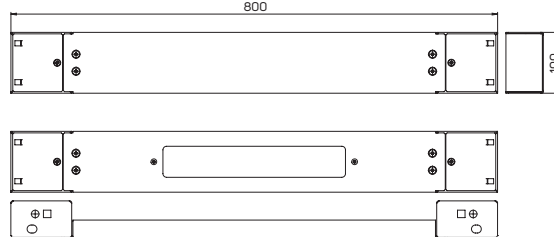

## SET OF SIDE PANELS

- Set of two plinth panels for RF1/RB1 racks—DP-P1-Sxxx
- Set of two plinth panels for Ri7/RM7 racks or CoolTeg—DP-P-Sxxx
- Height: 100 mm

\*\* Package includes:

- 2x side plinth panels, mounting kit

DP-P-S60

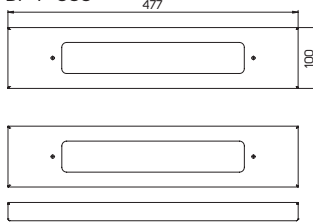

DP-P-S80

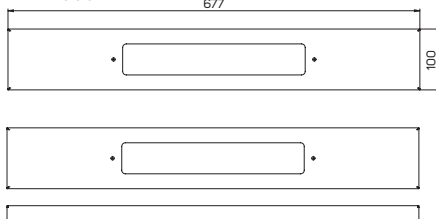

DP-P-S120/DP-P1-S120

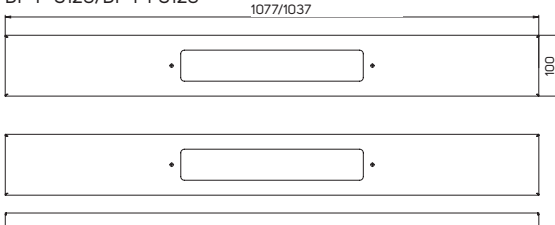

Code	Description	Depth (mm)	Package **
DP-P1-S60	Set of two side panels for plinth DP-PR-L, for RF1/RB1 racks of 600 mm depth, height 100 mm	600	1 set
DP-P1-S80	Set of two side panels for plinth DP-PR-L, for RF1/RB1 racks of 800 mm depth, height 100 mm	800	1 set
DP-P1-S100	Set of two side panels for plinth DP-PR-L, for RF1/RB1 racks of 1000 mm depth, height 100 mm	1000	1 set
DP-P1-S120	Set of two side panels for plinth DP-PR-L, for RF1/RB1 racks of 1200 mm depth, height 100 mm	1200	1 set
DP-P-S60	Set of two side panels for plinth DP-PR-L, for Ri7 racks of 600 mm depth or CoolTeg, height 100 mm	600	1 set
DP-P-S80	Set of two side panels for plinth DP-PR-L, for Ri7 racks of 800 mm depth or CoolTeg, height 100 mm	800	1 set
DP-P-S100	Set of two side panels for plinth DP-PR-L, for Ri7 racks of 1000 mm depth or CoolTeg, height 100 mm	1000	1 set
DP-P-S120	Set of two side panels for plinth DP-PR-L, for Ri7 racks of 1200 mm depth or CoolTeg, height 100 mm	1200	1 set
DP-P-S80	Set of two side panels for plinth DP-PR-L, RF1 rack depth 800 mm, height 100 mm	800	1 set
DP-P-S100	Set of two side panels for plinth DP-PR-L, RF1 rack depth 1000 mm, height 100 mm	1000	1 set
DP-P-S1200	Set of two side panels for plinth DP-PR-L, RF1 rack depth 1200 mm, height 100 mm	1200	1 set

DP-P-S100/DP-P1-S100

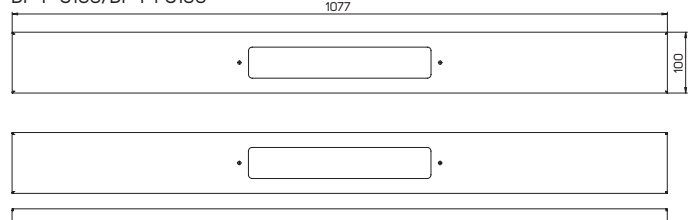

## ADJUSTABLE FEET FOR PLINTH

Code	Description	Package
DP-PR-L-A	Adjustable feet for plinth DP-PR-Lxx	4 pcs



## SET OF FRAMES WITH FILTERS FOR SIDE PANELS

Code	Description	Package
DP-P-F	Set of frames with filters for plinth side panels DP-P1-Sxx and DP-P-Sxx	2 pcs

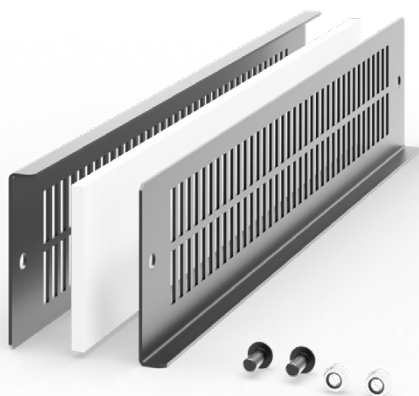

# MOUNTING & CONNECTING KITS

## MOUNTING KIT



DP-MO-01

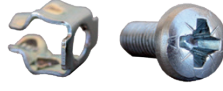

DP-MO-F2

- Attaches equipment to vertical extrusions
- Package includes:
  - DP-MO-0x: 1x screw, 1x floating nut, 1x washer
  - DP-MO-F2: 1x screw, 1x nut
  - DP-MO-100: 100x mounting kit (1x screw, 1x floating nut, 1x washer)

Code	Description	Size	Package
DP-MO-01 *	Mounting kit	M5	1 set
DP-MO-02 *	Mounting kit	M6	1 set
DP-MO-F2 *	Mounting kit—fast installation	M6	1 set
DP-MO-100	Mounting kit—multipack	M5	1 set

\* Please order in multiples of four only (one package = 4 sets, see above).

## CONNECTING KITS

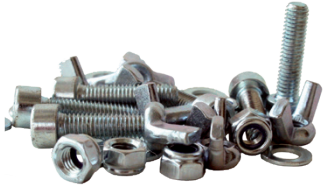

DP-DR-UNI



DP-DR-7



DP-DR-RF1

- Connects (bays) free-standing racks of the same height and depth into one row
- DP-DR-UNI: connects entire Ri7 rack row; side panels need not be removed
- DP-DR-7: connects entire Ri7 rack row; side panels must be removed
- DP-DR-RF1: connects RF1 and RB1 series racks
- DP-DR-RF1-AC: connects RF1 series racks and CoolTeg units through top covers

Code	Description	Package
DP-DR-UNI	Connecting kit for all Ri7 free-standing rack series	1 set
DP-DR-7	Connecting kit for all Ri7 series racks without side panels	1 set
DP-DR-RF1	Connecting kit for RF1/RB1 free-standing racks	1 set
DP-DR-SSP-RF1	Kit for securing RF1/RB1 side panels	1 set
DP-DR-RF1-AC	Kit for connecting RF1 with CoolTeg—top cover installation	1 set

- Package includes:
  - DP-DR-UNI: 6x butterfly nuts M5, 6x screws M5x20, 12x washers
  - DP-DR-7: 6x hexagonal nuts, 12x screws M5x10, 12x washers M5 DIN125
  - DP-DR-RF1: 4x frame connection, 16x screws M5x9
  - DP-DR-SSP-RF1: 8x side panel holder, 8x screws M5x9
  - DP-DR-RF1-AC: 2x top holder, 4x screws M5x9, 4x screws M6x12

# ACCESSORIES

## OTHERS

### 19" WALL-MOUNTING HOLDERS

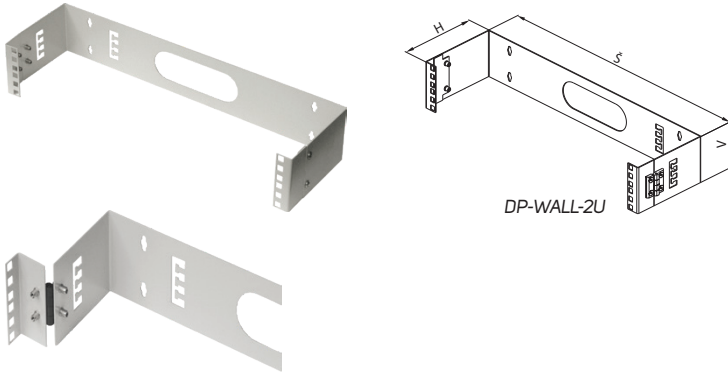

- For 19" wall equipment installation
- 2U and 4U in height
- Mounting holes (for wall installation) on rear
- Holder equipped with hinges (enables equipment to swing open from wall)
- Side cable entry openings
- Color: powder-coated RAL 7035
- Package includes: 1x Wall-mounting holder

Code	H (in U)	W	Depth (mm)	Package
DP-WALL-2U	2	19"	150	1 pc
DP-WALL-4U	4	19"	150	1 pc

### CASTORS & FEET



DP-KO-H1



DP-KO-H2



DP-KO-01



DP-KO-02



DP-NO-01



DP-KO-TC

- Package includes:
  - Set 1: 1x castor, 1x screw M10, 1x washer
  - Set 2: 1x foot
  - Set 3: 4x castors
  - Set 4: 1x castor, 1x adapter M10/M12; 1x connector M12/M12

Code	Description	Load rating per castor (kg) *	Package
DP-KO-01	Castor for free-standing rack	50 kg	1 pc of set #1
DP-KO-02	Lockable castor for free-standing rack	50 kg	1 pc of set #1
DP-KO-H1	High-load castor for free-standing rack	100 kg	1 pc of set #1
DP-KO-H2	Lockable high-load castor for free-standing rack	100 kg	1 pc of set #1
DP-NO-01	Adjustable foot for free-standing rack	-	1 pc of set #2
DP-KO-TC	Transport castors for free-standing racks	30 kg	1 pc of set #3
DP-KO-F1	Castor for free-standing rack, integrated adjustable leg	280 kg	1 pc of set #4
DP-KO-F5	Castor for free-standing rack, integrated adjustable leg	500 kg	1 pc of set #4

\* Castor load rating = (rack weight + device weight)/3

## LIGHTING UNIT



- Lamp: LED, 120° angle, 6500 K
- Luminosity: 400 lm
- Voltage/Frequency: 24-265 V DC/AC ~ 50/60 Hz
- Power consumption: 5 Watt
- Control of light: Built-in motion sensor, switch off time—5 min.
- Mounting: Magnets
- Operating temperature range: from -30 °C up to +70 °C
- Dimension: 357,4 × 32 × 35,5 mm (H × W × D)
- Weight: 140 g
- Certifications: CE, UL

Code	Description	Package
DP-OJ-06	Lighting unit 400 lm with motion sensor, 24–265 V DC/AC ~ 50/60 Hz, magnetic fixing	1 set

## CABLE PROTECTION IN OPENINGS



DP-KP-KAR



DP-KP-RB4

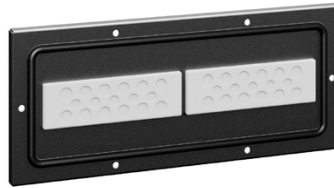

DP-KP-HCE2



DP-KP-KAR9

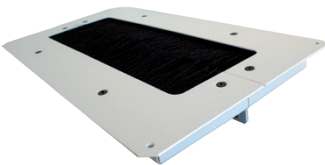

DP-KP-KAR-A



DP-KP-KAR7



DP-KP-KAR4



DP-KP-KAR4-D

- Protective strips and brush panels help protect cable entries, limiting dust penetration
- Installed in cable entry openings (300 × 100 mm or 300 × 50 mm)
- Mounting holes (for wall installation) on rear

Code	Description	Available colors		Package
		RAL 7035	RAL 9005	
DP-KP-LEM	Protective edging of cable entries (length 790 mm)	–	✓	1 pc
DP-KP-HCE2	Hermetic cable entry for rack with IP54 (opening 300×100 mm)	✓	✓	1 pc
DP-KP-KAR	Cable entry covered with brush for iSEVEN and Premium series (opening 300×100 mm)	✓	✓	1 pc
DP-KP-KAR3	Cable entry 150×56 mm covered with brush for RUN, RUD, REN series	✓	–	1 pc
DP-KP-KAR4	Cable entry, two layers of brushes (opening 300×100 mm)	✓	✓	1 pc
DP-KP-KAR4-D	Cable entry, two layers of brushes, divided version (opening 300×100 mm)	✓	✓	1 pc
DP-KP-KAR5	Cable entry 300×50 mm, covered with brush	✓	✓	1 pc
DP-KP-KAR6	Dust-proof brush for cable entry 500×110 mm (for Ri7/RM7), two pieces of brushes and two pieces of rubber for edges of cable entry	–	✓	1 pc
DP-KP-KAR7	Slidable cover for cable entry 300×100 mm	✓	✓	1 pc
DP-KP-KAR9	Cable entry with radius cable protection, for 300×100 mm opening	✓	✓	1 pc
DP-KP-RB4	Cable entry diameter 100 mm (4"), covered with brush	–	✓	1 pc
DP-KP-RP4	Cable entry diameter 100 mm (4"), plastic	–	✓	1 pc
DP-KP-KAR-A	Cable entry for raised floor tiles, two layers of brushes (opening 410×215 mm)	✓	✓	1 pc